

Montaje / Assembly / Montaggio / Montage/ Montagem

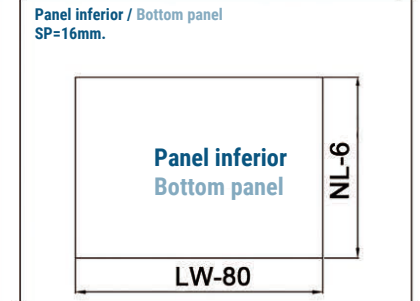
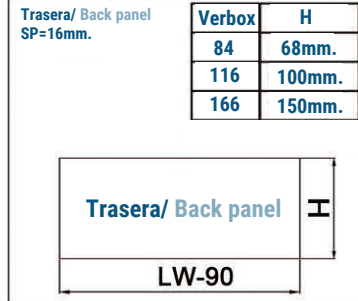
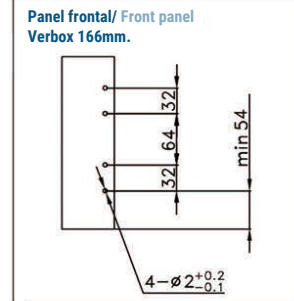
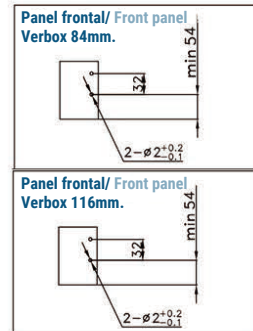
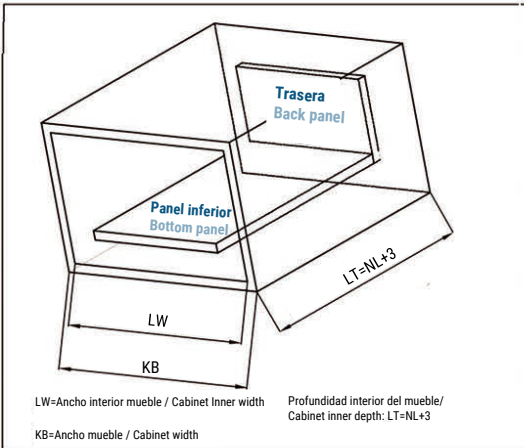
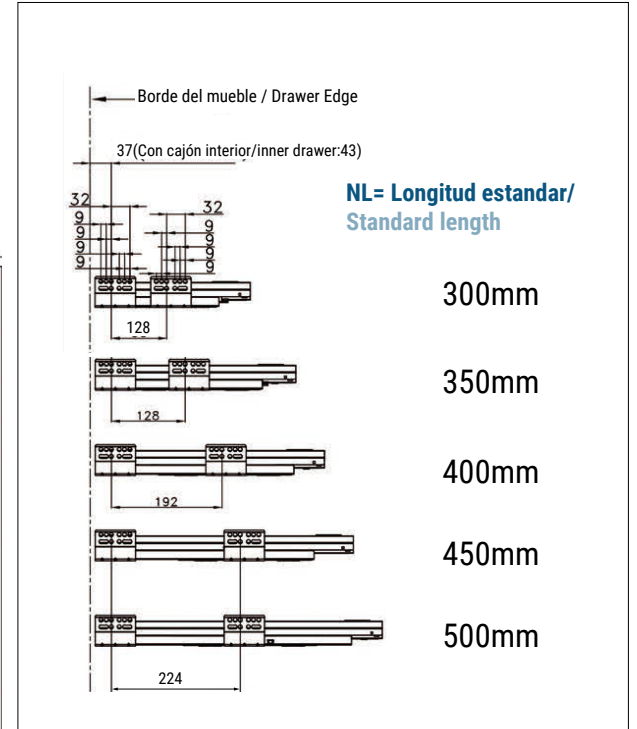
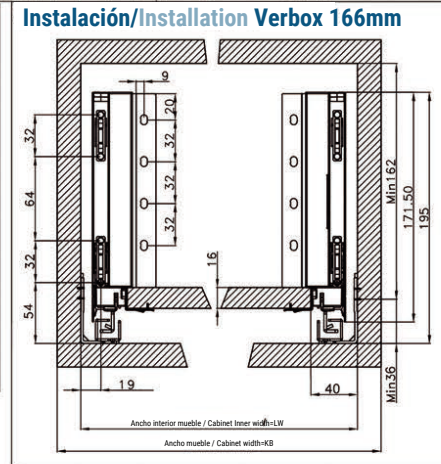
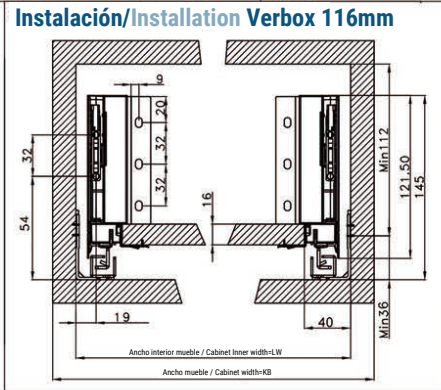
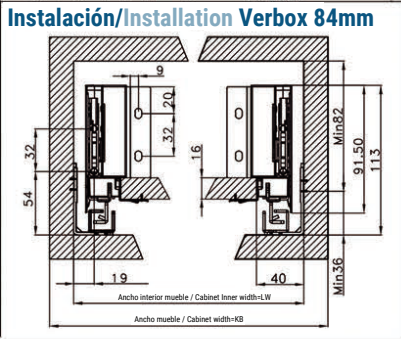
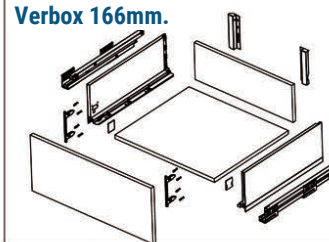
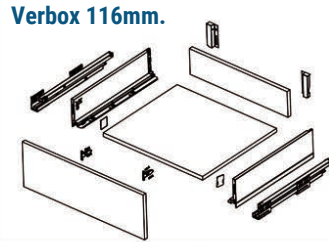
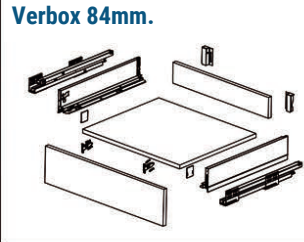

Montaje / Assembly / Montaggio / Montage/ Montagem

Instalación /Installation Verbox

1 Trasera /Back panel

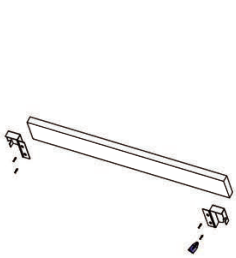

2 Colocación de soportes/ Insert the brackets

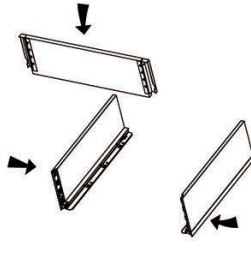

3 Panel inferior/ Bottom panel

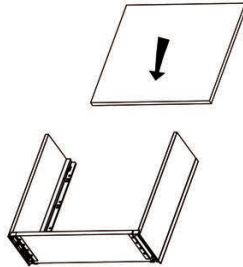

4 Instalación del Panel frontal/ Front panel installation

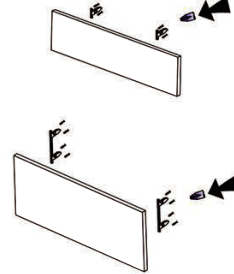

4 Colocación del panel frontal/ Insert front panel

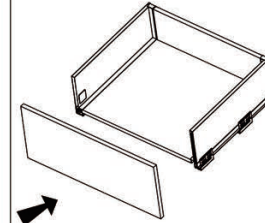

4 Colocación del tornillo rapido/ Fasten screws

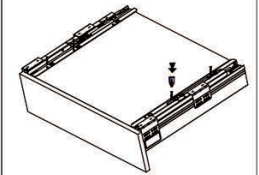

Ajustes del cajón/ Drawer adjusting Verbox

Panel frontal izquierda y derecha / Frontal panel left & right $\pm 1,5$ mm.

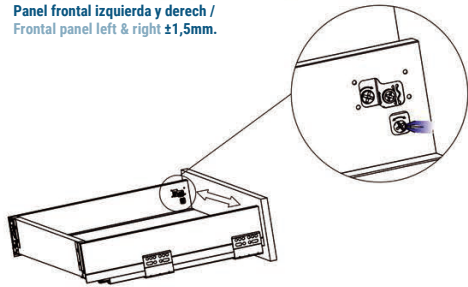

Panel frontal arriba y abajo / Frontal panel up & down $\pm 1,5$ mm.

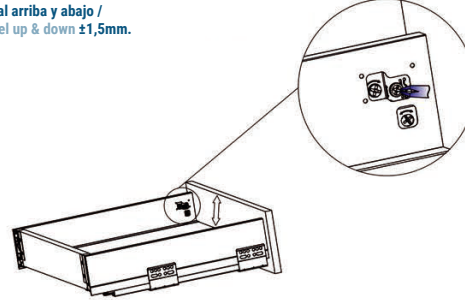

Presiona la tapa y deslízcela dentro el cajón/ Press in cover and slide into the drawer

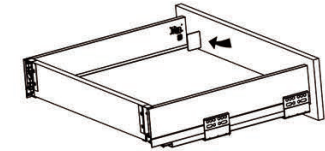

Desmontaje del cajón/ Drawer Removing Verbox

Quite la tapa con la mano estirando hacia fuera / Open the cover cap by hand and pull it out

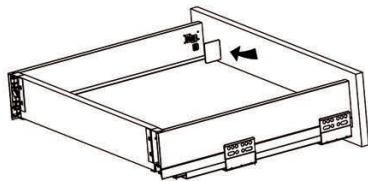

Use un destornillador para soltar el tornillo del soporte frontal / Use the screw driver to loose the drawer front panel

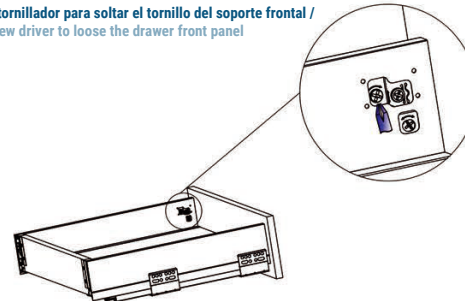

Presiona el gatillo y extraer el cajón horizontalmente / Press the trigger, pull out the drawer horizontally

